

ITEM NO.	PART NUMBER	DESCRIPTION	QTY.
1	172213	4000L VERTICAL TANK	1
2	135362	Ø 620 SCREW LID & RIM	1

DESIGN DATA	
DESIGN PRESSURE: ATMOSPHERIC	MAXIMUM CAPACITY (LTRS): 4420
DESIGN TEMPERATURE: 40°C	WORKING CAPACITY (LTRS): -
WORKING PRESSURE: ATMOSPHERIC	APPROX. WEIGHT FULL (KGS): 4520
WORKING TEMPERATURE: 40°C	APPROX. WEIGHT EMPTY (KGS): 100
MOULDED LIFTING LUGS: 4 - 0°, 90°, 180° & 270°	
METHOD OF SUPPORT: FIRM, FLAT, FULLY SUPPORTING BASE OF CONCRETE OR OTHER SUITABLE MATEREAL	

MATERIAL DATA
MATERIALS OF CONSTRUCTION: MATRIX REVOLVE N-307. REVOLVE IS A HIGH DENSITY (0.939 g/cm3), LOW MELT (3.5 g/ 10 min) HEXENE POLYETHYLENE GRADE FOR ROTOMOULDING. THE GRADE IS FULLY PROTECTED AGAINST THERMAL AND LIGHT DEGRADATION: N-307 IS UV10 STABILISED.

INSPECTION AND TESTING
WORKS TEST: ALL TANKS ARE THICKNESS TESTED BY ULTRASOUND AFTER DEMOULD IN ADDITION AIR SUPPORTED LEAK TEST ARE CARRIED OUT ON FLANGE LINES.

NOTE SECTION

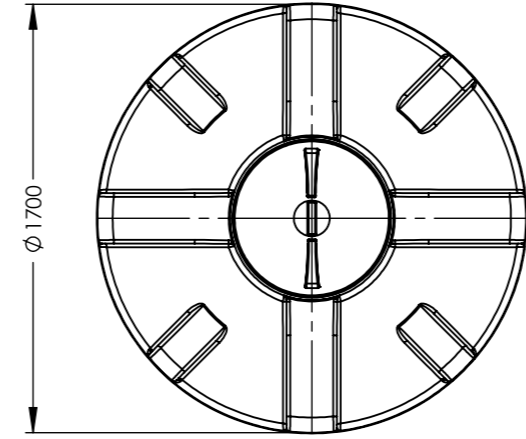

PLAN VIEW

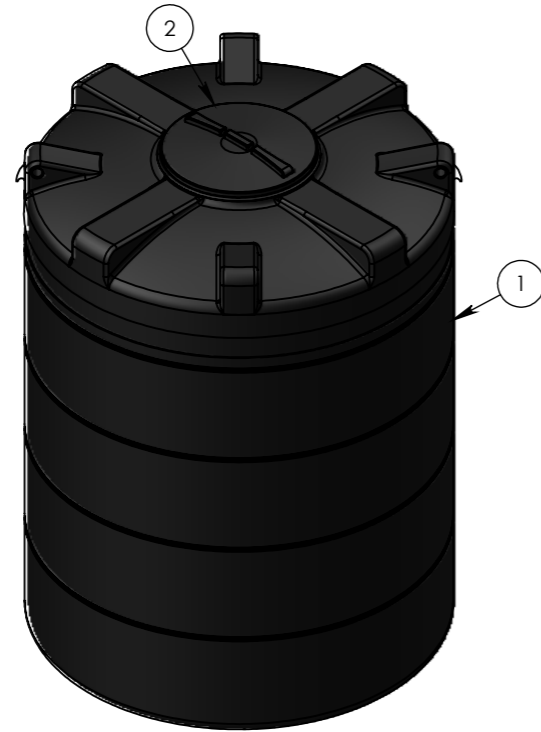

LEFT ISO VIEW

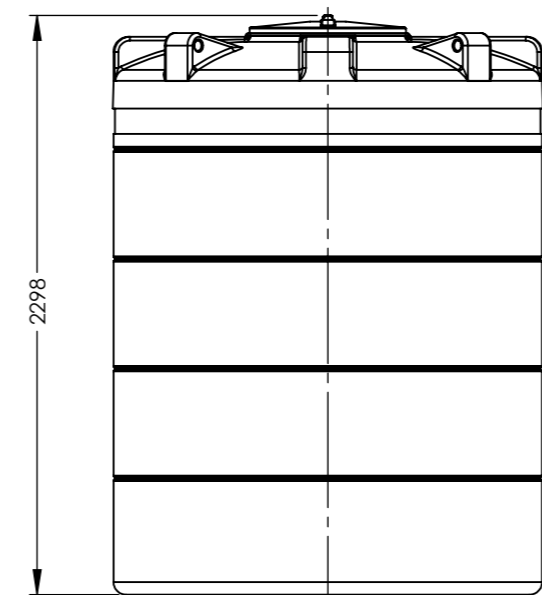

FRONT VIEW

	NAME	SIGNATURE	DATE
DRAWN	LC	L.Crane	25/06/2021
CHECKED			

UNLESS OTHERWISE SPECIFIED:
DIMENSIONS ARE IN MILLIMETERS
SURFACE FINISH: MDPE
TOLERANCES: ±3%

3RD ANGLE PROJECTION

DO NOT SCALE DRAWING REVISION: -

ENDURAMAXX®
FLUID MANAGEMENT INNOVATION

DWG TITLE:
4000L VERTICAL TANK

DWG NO: 172213-4000L-VERTICAL A3

SCALE: 1:30 SHEET 1 OF 1